

# CWTe Research Retreat 2015

Peter Baltus  
20151021



# Welcome!

to the 6<sup>th</sup> CWTe  
Research Retreat

# Invitation CWTe 2015 Research Retreat

**Wednesday, 21<sup>st</sup> of October 2015**  
**De Zwarte Doos, 1<sup>st</sup> floor, TU Eindhoven**

Hosted by: Centre for Wireless Technology Eindhoven

- 9.00 - Welcome with coffee  
**Morning program**
  - 9.30 Opening and introduction
  - 9.40 Chickens go wireless
  - 10.20 The Future of Wireless Communication System Design
  - 11.00 - Break (incl. posters)
  - 11.20 Wireless challenges in the 'Ageing in Place' environment  
**Lunch**
  - 12.00 - Lunch (incl. posters)  
**Afternoon program**
  - 12.45 Lab Tour CWTe Labs Flux building
  - 13.45 Cognitive radio – new players, a different game
  - 14.25 Exploration with bare sensor balls
  - 14.55 - Break (incl. posters)
  - 15.15 Indoor Optical Wireless Communication using Steered Pencil Beams
  - 15.45 Interference Suppression Techniques for mm-Wave Integrated Rx FEs  
**Closing**
  - 16.15 Closing session
  - 16.30 - Drinks and networking
- Peter Baltus (TU/e, CWTe)**  
**Jack Abrahams (Vencomatic), et al**  
**Gerd Ascheid (RWTH Aachen)**
- Jan Poessé (Philips)**
- Erik Fledderus (SURF, TU/e)**  
**Erik Duisterwinkel (INCAS3, TU/e)**
- Ton Koonen (TU/e)**  
**Chuang Lu (TU/e, IMEC-NL)**
- Peter Baltus (TU/e, CWTe)**

**For registration:** visit [www.tue.nl/cwte](http://www.tue.nl/cwte)

## Centre for Wireless Technology Eindhoven



Program Board Chairs



Bus. Dev.



Everything Else



Architecture Team

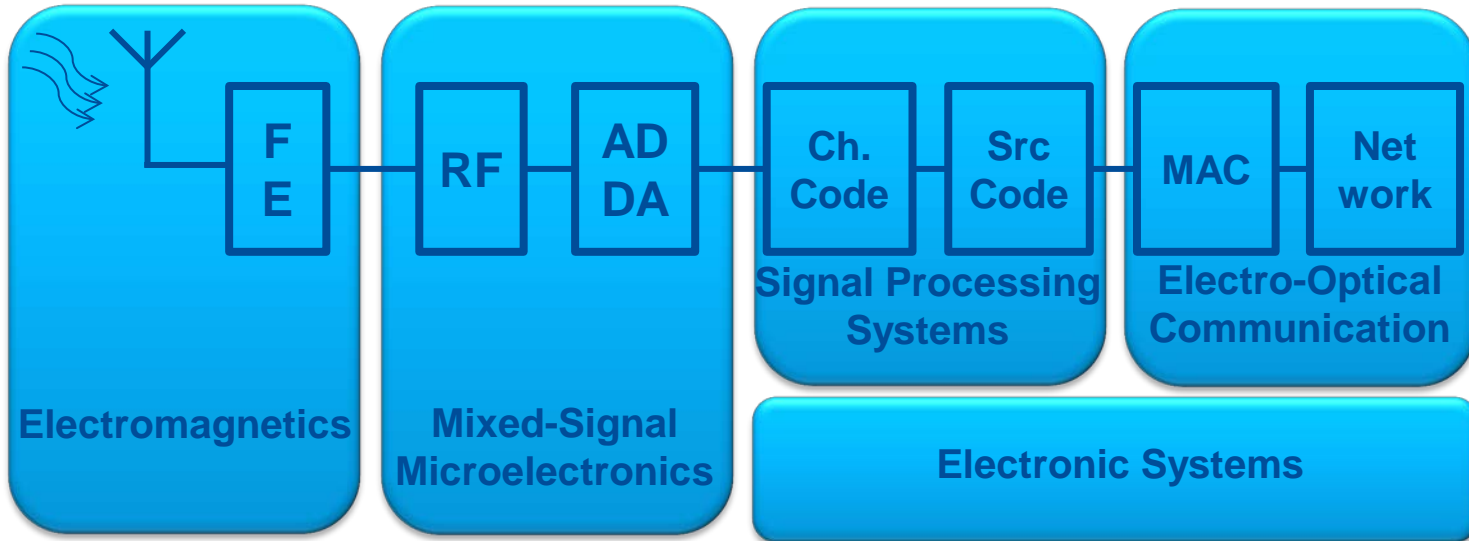

EM

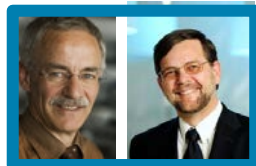

MsM



SPS



ES



ECO

# Research Programs:



**UHDR**

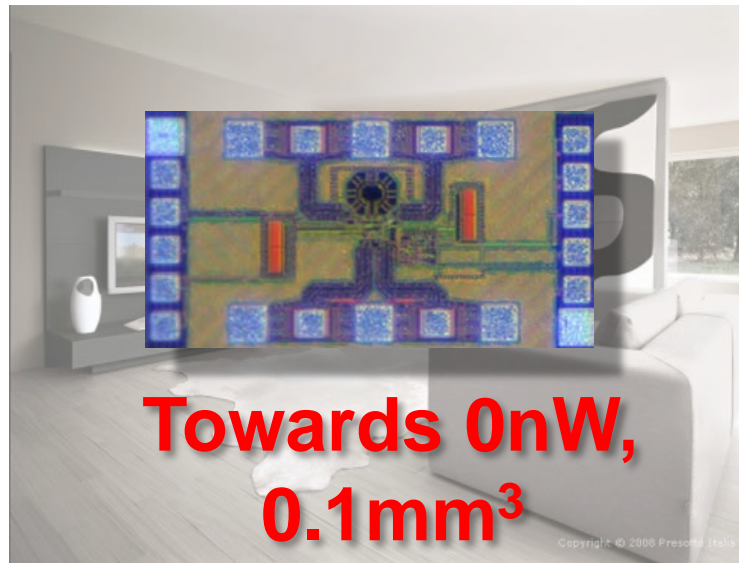

**ULP**



**SRTO**

- **Very strong growth in freshmen since 2010**
- **Will start to result in more graduates from ~ 2016**
- **FLUX might have been bigger...**
- **BSc college**
- **Graduate school**
- **Connected World track**
  
- **Wireless Architect i.s.n.**

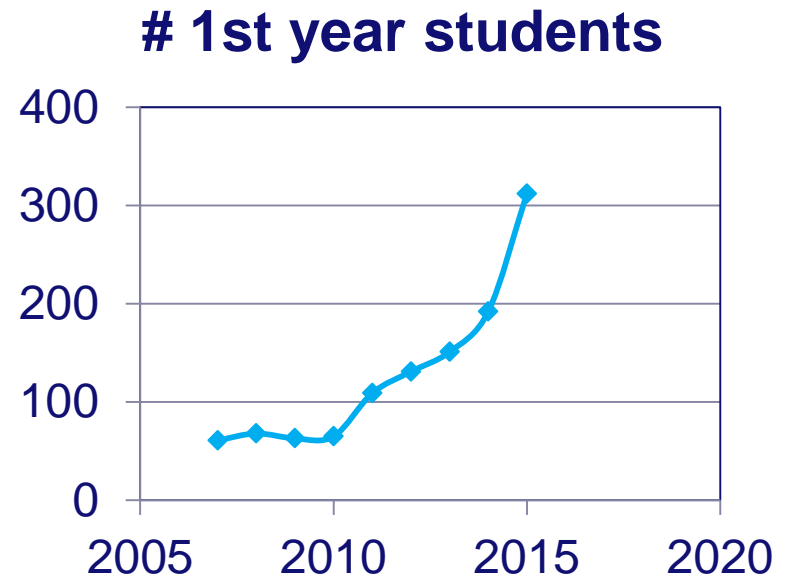

# Visions... Planning... Building... Success!

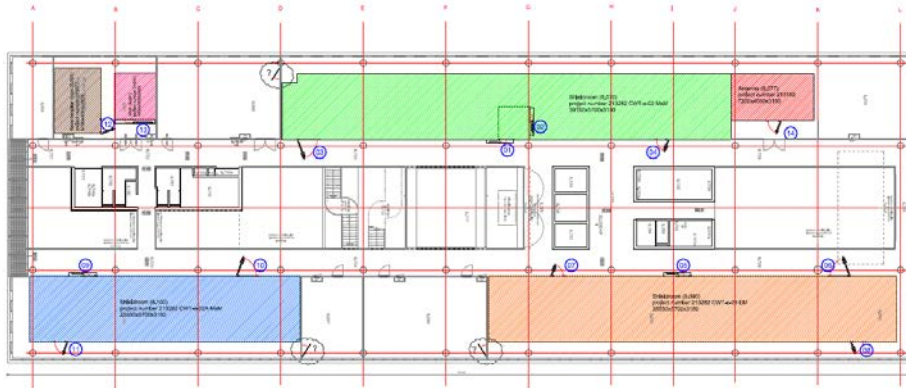
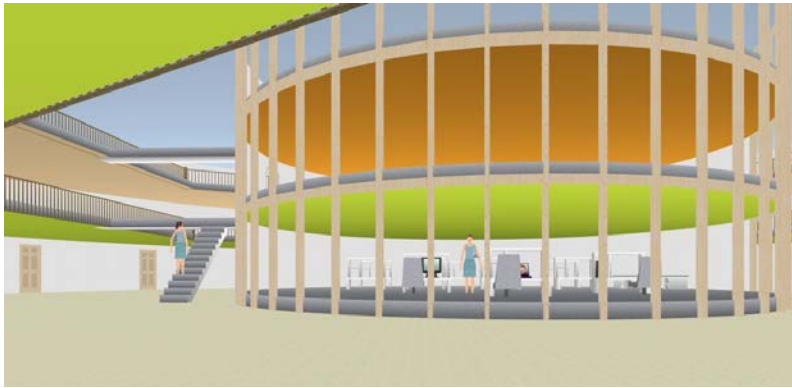





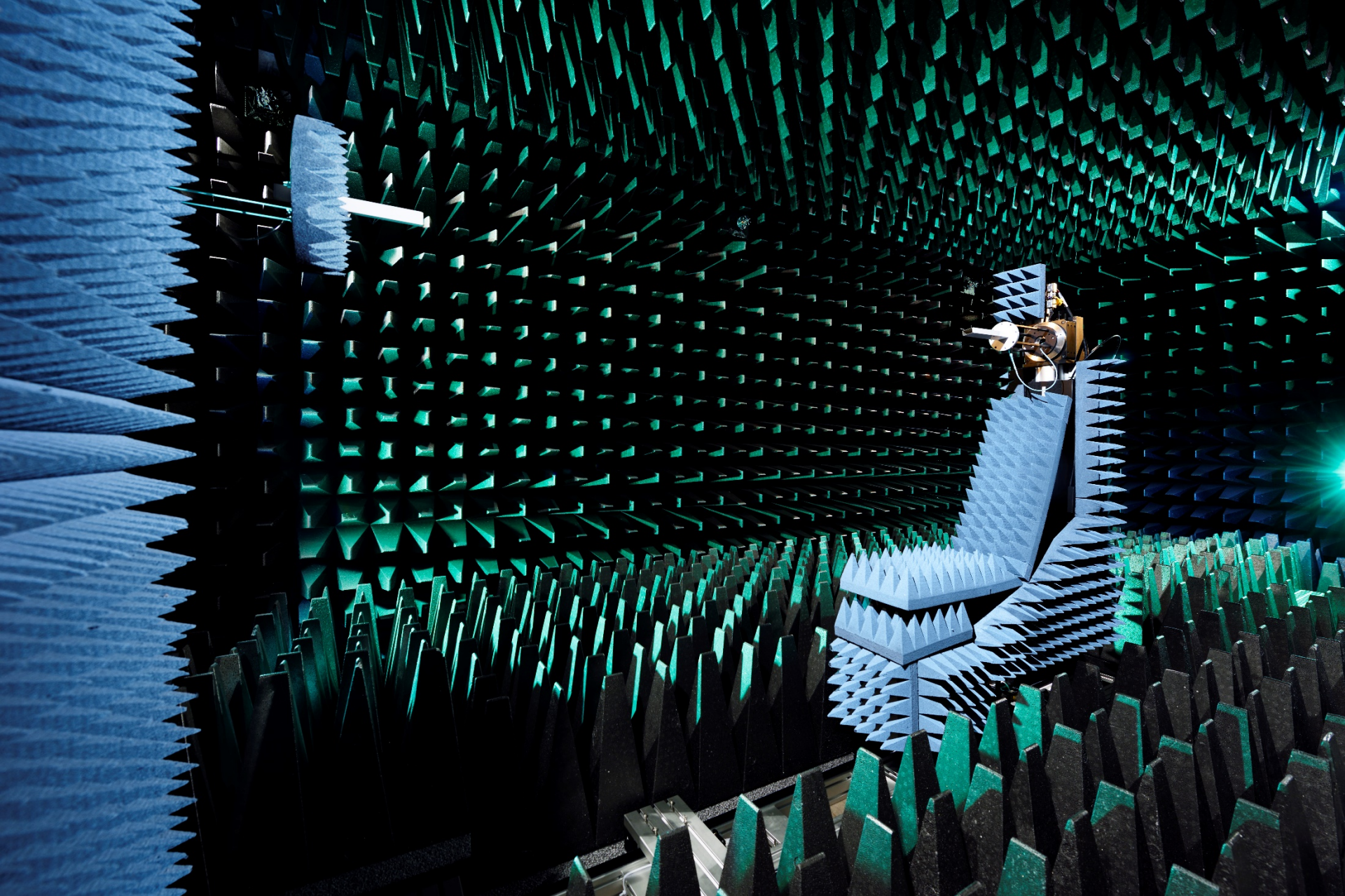



**Check it out!**  
**Lab visit @ 12:45**  
**(Right after lunch)**

**More information at end  
of the morning session**

